

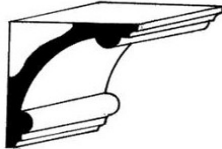







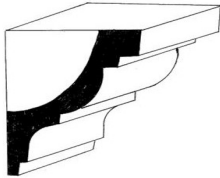

Gipsz Húzott Léc

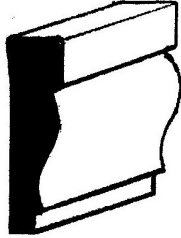
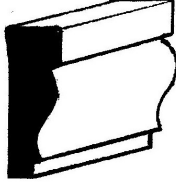
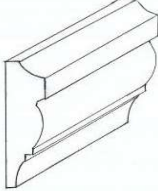
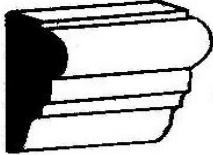
Profil	Típus	Méret (cm) (mag.x szél.)	Átfogó (cm)	Nettó	Bruttó
	H-14	10,5 x 9,5	14	1,820 Ft	2,311 Ft
	V-91	9 x 5	10	1,300 Ft	1,651 Ft
	SL-6D	6 x 6	8.5	1,105 Ft	1,403 Ft
	V-100	8 x 6	10	1,300 Ft	1,651 Ft
	V-100 nagy	10 x 6	12	1,560 Ft	1,981 Ft
	Kis pillangó	5 x 4,5	6.7	871 Ft	1,106 Ft
	V-95 cs.	10 x 2,5	-	1,300 Ft	1,651 Ft

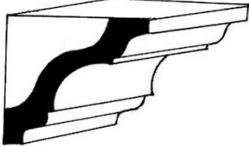

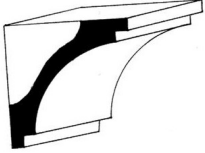
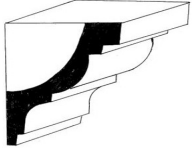
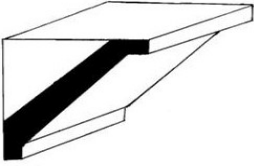
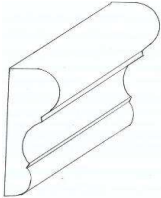
Gipsz Húzott Léc

Profil	Típus	Méret (cm) (mag.x szél.)	Átfogó (cm)	Nettó	Bruttó
	V-95 cs. kicsi	6 x 2,3	–	780 Ft	991 Ft
	V-95 kicsi	6,5 x 2,8	–	845 Ft	1,073 Ft
	V-65	7 x 2,5	–	910 Ft	1,156 Ft
	V-10	5 x 2,3	–	650 Ft	826 Ft
	V-83	9 x 8	12	1,560 Ft	1,981 Ft
	SL-7	7,5 x 6,5	10	1,300 Ft	1,651 Ft

Gipsz Húzott Lécek

Profil	Típus	Méret (cm) (mag.x szél.)	Átfogó (cm)	Nettó	Bruttó
	SL-6H	7 x 5	9	1,170 Ft	1,486 Ft
	V-100 kicsi	6,5 x 6	9	1,170 Ft	1,486 Ft
	H-10	7 x 7	10	1,300 Ft	1,651 Ft
	V-32	8 x 3	-	1,040 Ft	1,321 Ft
	V-32 kicsi	4 x 1,5	-	650 Ft	826 Ft
	V-106	6,5 x 2,5	-	845 Ft	1,073 Ft
	V-106	4,5 x 2,5	-	650 Ft	826 Ft
	Sz- Szim.eo	4 x 1,5	-	650 Ft	826 Ft

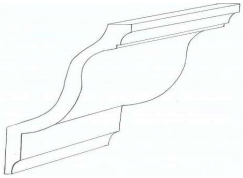
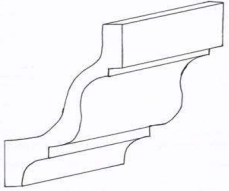
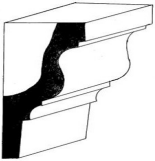
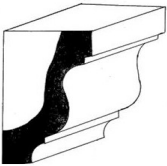
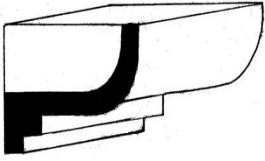

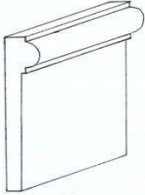
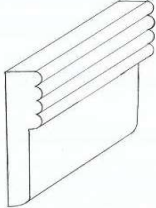
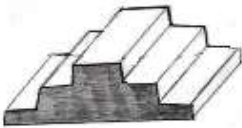
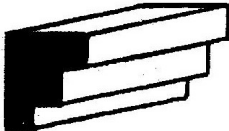
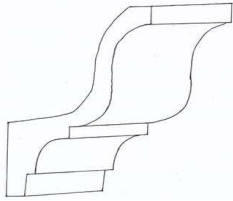
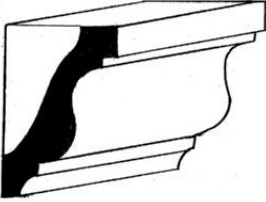

Gipsz Húzott Lécek

Profil	Típus	Méret (cm) (mag.x szél.)	Átfogó (cm)	Nettó	Bruttó
	Sz-3	3 x 1,5	–	650 Ft	826 Ft
	RV-18	14 x 11	18	2,340 Ft	2,972 Ft
	RV-16	13,5 x 9	16	2,080 Ft	2,642 Ft
	V-104	9 x 4	10	1,300 Ft	1,651 Ft
	V-102	6 x 4	7	910 Ft	1,156 Ft
	RV-8	6,5 x 5	8	1,040 Ft	1,321 Ft
	RV-22		22	2,860 Ft	3,632 Ft
	SZ-20	20 x 3,5	–	2,600 Ft	3,302 Ft

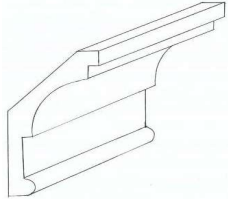
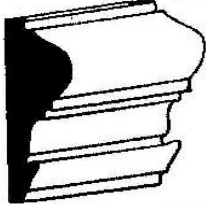

Gipsz Húzott Léc

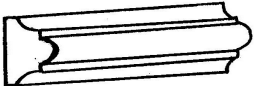
<i>Profil</i>	<i>Típus</i>	<i>Méret (cm) (mag.x szél.)</i>	<i>Átfogó (cm)</i>	<i>Nettó</i>	<i>Bruttó</i>
	SZ-10	10 x 2	–	1,300 Ft	1,651 Ft
	SZ-7	7 x 1,8	–	910 Ft	1,156 Ft
	SZ-L6	6 x 2	–	780 Ft	991 Ft
	SZ-L3	3 x 2	–	650 Ft	826 Ft
	RV-20	17 x 11	20	2,600 Ft	3,302 Ft
	RV-14	11 x 7,5	14	1,820 Ft	2,311 Ft

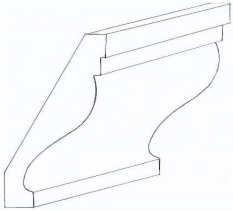
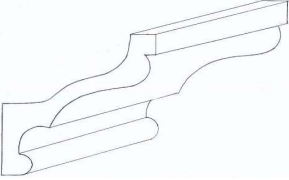

Gipsz Húzott Léc

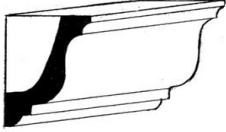
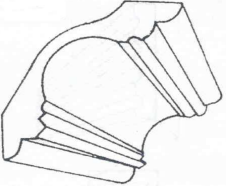
Profil	Típus	Méret (cm) (mag.x szél.)	Átfogó (cm)	Nettó	Bruttó
	H-P12	10 x 5,5	12	1,495 Ft	1,899 Ft
	V-62	15 x 4,5	–	1,950 Ft	2,477 Ft
	V-119	14 x 4,4	–	1,820 Ft	2,311 Ft
	V-119	12 x 4,3	–	1,560 Ft	1,981 Ft
	V-119	10 x 4	–	1,300 Ft	1,651 Ft
	V-119	8 x 2,5	–	1,040 Ft	1,321 Ft
	V-119	5,5 x 2	–	715 Ft	908 Ft
	V-106	3 x 1,7	–	650 Ft	826 Ft
	Kis puty	2,5 x 1,3	–	650 Ft	826 Ft
	H14/2	12,5 x 7	14	1,820 Ft	2,311 Ft
	P-RV 13,5	9 x 9,5	13	1,690 Ft	2,146 Ft

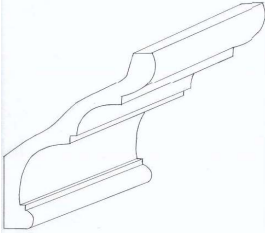
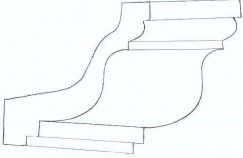
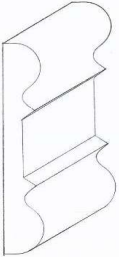
Gipsz Húzott Lécek

Profil	Típus	Méret (cm) (mag.x szél.)	Átfogó (cm)	Nettó	Bruttó
	RV-15 (V-147)	12 x 8	14	1,820 Ft	2,311 Ft
	H-21 (V-92)	13,5 x 13,5	19	2,470 Ft	3,137 Ft
	F19	18 x 6,5	19	2,470 Ft	3,137 Ft
	P-RV 19	17 x 11,5	21	2,730 Ft	3,467 Ft
	RV-16/1	12 x 11	16	2,080 Ft	2,642 Ft
	Sz-11	11 x 2	-	1,430 Ft	1,816 Ft

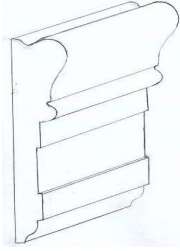
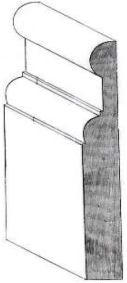

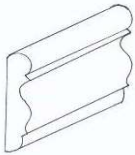
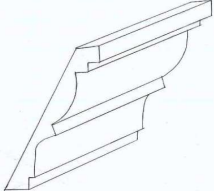
Gipsz Húzott Léc

Profil	Típus	Méret (cm) (mag.x szél.)	Átfogó (cm)	Nettó	Bruttó
	Szepesi 15	15 x 4,5	–	1,950 Ft	2,477 Ft
	Lábazat 15	15 x 2,2	–	1,950 Ft	2,477 Ft
	Bolti lábazat	15 x 4,5	–	1,950 Ft	2,477 Ft
	V-28 eo.	4,5 x 1	–	650 Ft	826 Ft
	V-100 tetőtéri	–	12	1,560 Ft	1,981 Ft

Gipsz Húzott Léc

<i>Profil</i>	<i>Típus</i>	<i>Méret (cm) (mag.x szél.)</i>	<i>Átfogó (cm)</i>	<i>Nettó</i>	<i>Bruttó</i>
	H-13	9,5 x 9	13	1,690 Ft	2,146 Ft
	Lépcsős	8 x 8	11	1,430 Ft	1,816 Ft
	Nagy címeres	18 x 18	25	3,250 Ft	4,128 Ft
	Kis címeres	14 x 13	19	2,470 Ft	3,137 Ft
	H-12	12 x 6,5	14	1,820 Ft	2,311 Ft
	Timp. oszloptalp	11 x 4,6	-	#VALUE!	#VALUE!

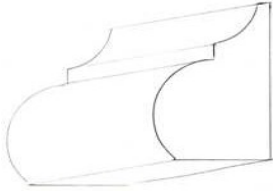
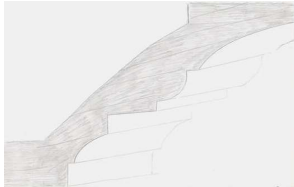
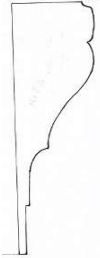
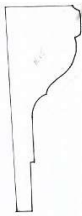
Gipsz Húzott Lécék

Profil	Típus	Méret (cm) (mag.x szél.)	Átfogó (cm)	Nettó	Bruttó
	Köves oszloptalp	7,8 x 5,2	10	1,300 Ft	1,651 Ft
	Hom-1	20,5 x 30	37	4,810 Ft	6,109 Ft
	Hom-2	18 x 5,2	19	2,470 Ft	3,137 Ft
	Hom-3	16 x 5	17	2,210 Ft	2,807 Ft
	Hom-4	8 x 3,4	9	1,170 Ft	1,486 Ft